

Zestawienie kolorystyczne - Kaiva

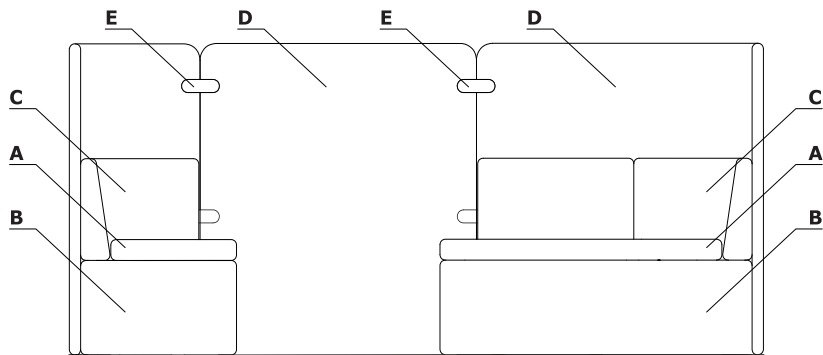

Materiał	Kolor	KAIVA																
		A - Siedzisko	B - Poduszka	C - Oparcie	D - Panel	E - łączniki												
Tkanina	Medley	✓	✓	✓	✓													
	Vita	✓	✓	✓	✓													
	Synergy	III grupa	III grupa	III grupa	III grupa													
	Metal - M154 - antracyt półmat					✓												

Opis techniczny

- 1 **Panel** - stelaż drewniany, tapicerowany
- 2 **Siedzisko, oparcie** - płyta wiórowa pokryta pianką, gęstość 55 kg/m³, tapicerka
- 3 **Podstawa** - skrzynia, stelaż drewniany, tapicerowana
- 4 **Stelaż drewniany**
- 5 **Łączniki** - metal malowany proszkowo, w komplecie, 4 szt./ panel

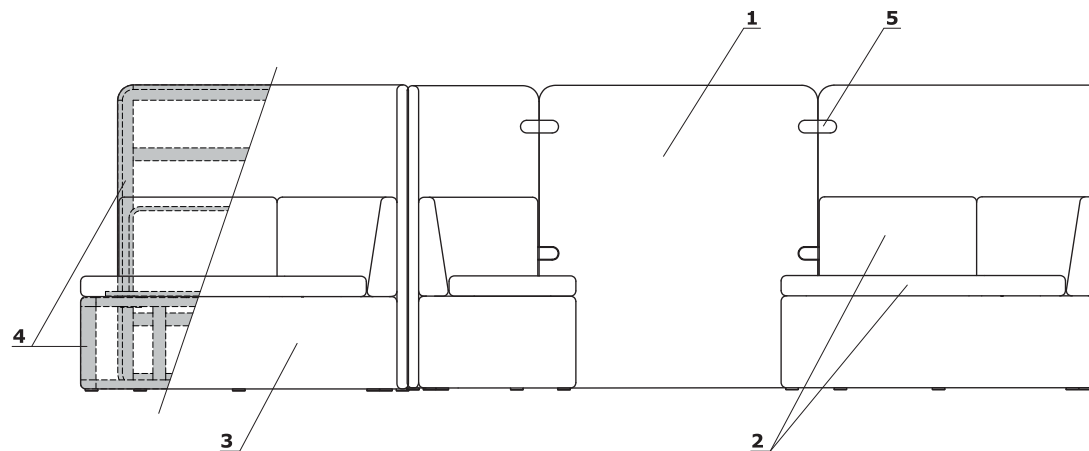





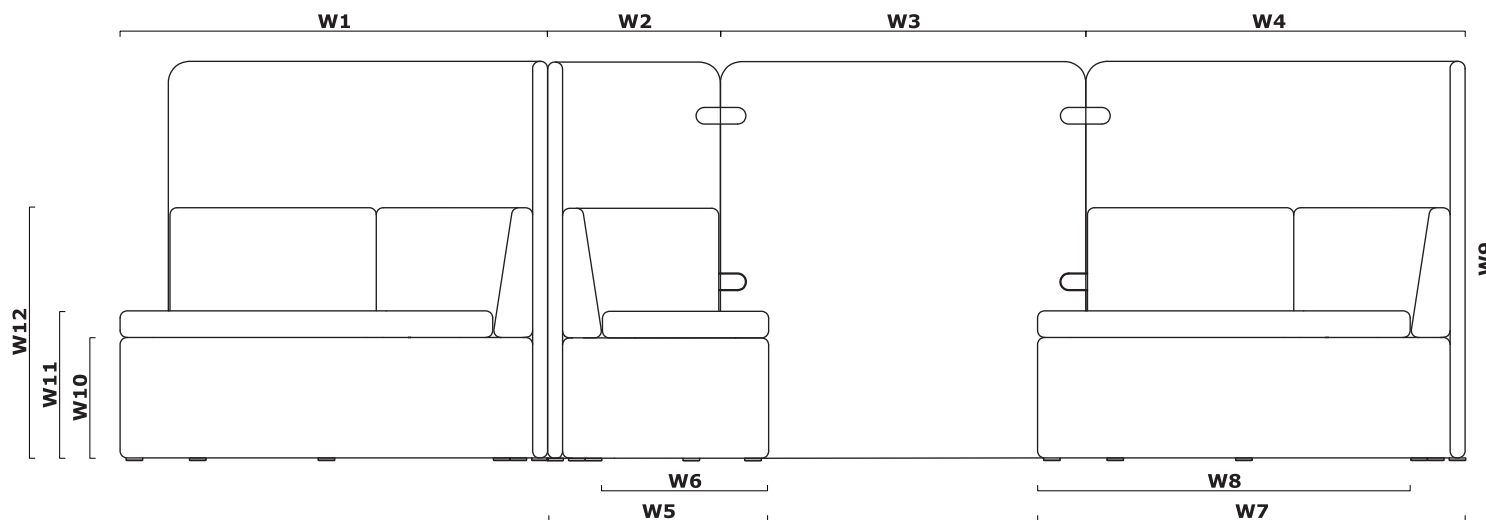



- max. obciążenie - 120 kg

Wymiary (mm)

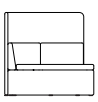
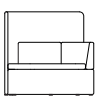

W1 - 1285 | W2 - 580 | W3 - 1100 | W4 - 1245 | W5 - 665 | W6 - 500 | W7 - 1285 | W8 - 1120 | W9 - 1350 | W10 - 370 | W11 - 450 | W12 - 760|

	Symbol	II	III	Waga Obj. Opak.	Informacje dodatkowe
		Medley, Vita	Synergy		
	KAV1			30 0,666 1	siedzisko małe z panelem wysokim
	KAV2P			30 0,666 1	siedzisko małe z oparciem prawym i panelem wysokim lewym
	KAV2L			30 0,666 1	siedzisko małe z oparciem lewym i panelem wysokim prawym
	KAV3			25 0,333 1	siedzisko małe bez panela
	KAV4P			40 1,261 1	siedzisko duże z panelem wysokim prawym
	KAV4L			40 1,261 1	siedzisko duże z panelem wysokim lewym
	KAV5P			40 1,261 1	siedzisko duże z oparciem prawym i panelem wysokim lewym
	KAV5L			40 1,261 1	siedzisko duże z oparciem lewym i panelem wysokim prawym
	KAV6P			35 0,652 1	siedzisko duże bez panela, prawe

	Symbol	II	III	Waga Obj. Opak.	Informacje dodatkowe
		Medley, Vita	Synergy		
	KAV6L			35 0,652 1	siedzisko duze bez panela, lewe
	KAV10			10 0,116 1	panel wysoki